

# The Garage Light

## TECHNICAL SPECIFICATIONS

16 times brighter than a typical 60-watt incandescent bulb, pre-wired for simple installation, and featuring an amazingly durable aluminum body, The Garage Light is the last light you'll ever need.

### BRIGHT AS HELL, TOUGH AS NAILS

- **Construction** — Housed in a single piece of anodized, extruded aluminum to provide superior heat dissipation and impact resistance.
- **Applications** — Delivers brilliant, energy-efficient illumination to personal spaces like garages, workshops, boathouses, and more.
- **Maintenance** — Hinged door allows access to power supply. Patent-pending diffused lumen maintenance trays protect LEDs and allow for easy cleaning.
- **Reliability** — Predicted to maintain 70% of initial light output for up to 150,000 hours at 77°F (25°C).
- **Environment** — Suitable for dry and damp interior spaces.
- **Optional Accessories** — Occupancy sensor; Wall/Column mount



Hinged door access to power supply



Diffused lumen maintenance trays

### Technical Specifications

Weight	Power Input	Current	Wattage <sup>1</sup>	Lumens <sup>1</sup>	Efficacy <sup>1</sup>	Color Temperature	Typical CRI	Ambient Operating Temperature	Dimming
16 lb (7.3 kg)	120–277 V	0.77 A	88 W	12,740 lm	140 lm/W	4000K 5000K	80+	Up to 158°F (70°C)	Not Available

<sup>1</sup>Measured at 277 V, 4000K color temperature without lens

### Ordering Information

Lighting	Series	Lumen Output	Color Temperature	System Voltage	Lumen Maintenance Tray	Cord Length	Mounting Hardware	Controls
BAL	SHL3	13: 13K lm	04: 4000K 05: 5000K	01: 120–277 V	Diffuse Only	10: 10 ft (3.05 m) with plug	09: S Hooks	00: No external dimming 01: Occupancy/Photo

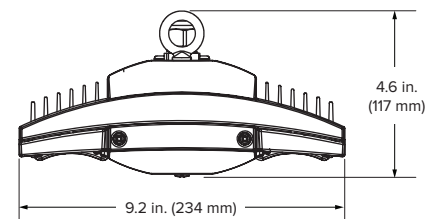
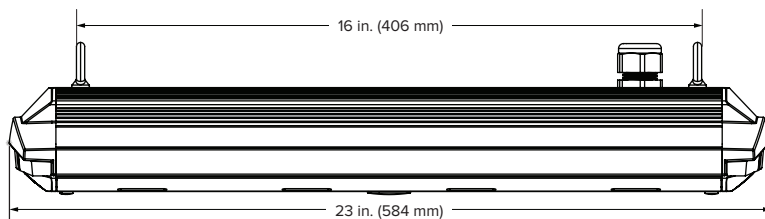

Certified to UL 1598 and  
CSA C22.2 No.250.0

See full warranty for coverage information.  
Lead times may vary depending on options.  
Specifications subject to change without notice.



AMERICAS  
BIGASSOLUTIONS.COM  
877-244-3267

CANADA  
BIGASSOLUTIONS.COM/CA  
844-924-4277

AUSTRALIA  
BIGASSOLUTIONS.COM/AU  
1-300-244-277

SINGAPORE  
BIGASSOLUTIONS.COM/SG  
+65 6709 8500

MALAYSIA  
+603 5565 0888

Accessory:

# Occupancy Sensor

## TECHNICAL SPECIFICATIONS

### FEATURES

- Seamlessly integrated into the fixture
- 360 degrees of monitoring coverage to automatically turn the light on when a space is occupied and off when it's vacant
- Timed delay turns light off after space is vacant for 10 minutes

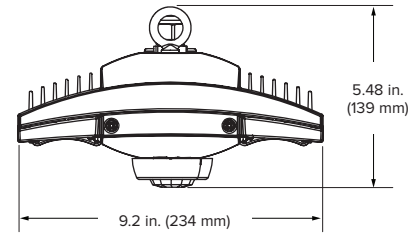
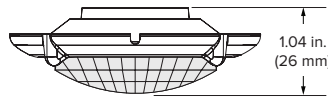
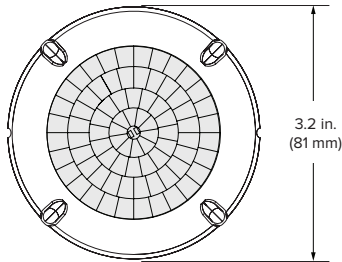

Top View Coverage

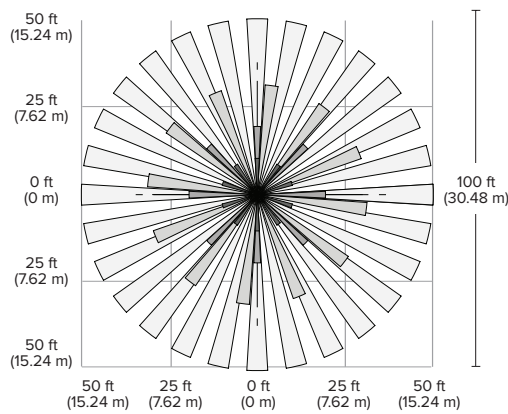

Side View Coverage

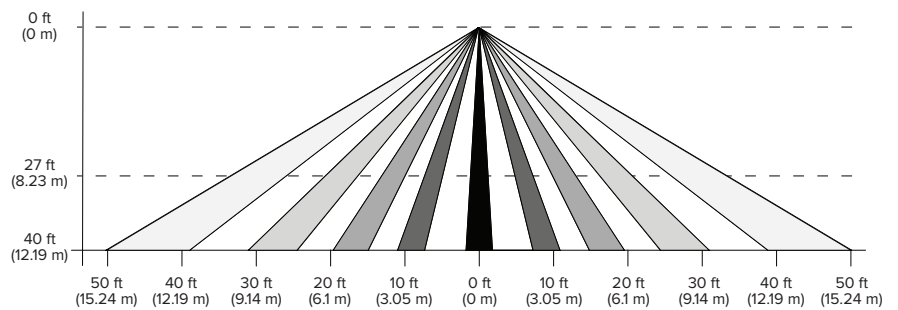

*See full warranty for coverage information.  
Specifications subject to change without notice.  
Lead times may vary depending on options selected.*



AMERICAS  
BIGASSOLUTIONS.COM  
877-244-3267

CANADA  
BIGASSOLUTIONS.COM/CA  
844-924-4277

AUSTRALIA  
BIGASSOLUTIONS.COM/AU  
1-300-244-277

SINGAPORE  
BIGASSOLUTIONS.COM/SG  
+65 6709 8500

MALAYSIA  
+603 5565 0888

Accessory:

# Wall/Column Mount

## TECHNICAL SPECIFICATIONS

### FEATURES

- Rotate fixture 360 degrees for direct, focused light
- Constructed from super-durable aluminum
- Built to last, even in tough spaces
- Compatible with I-beams

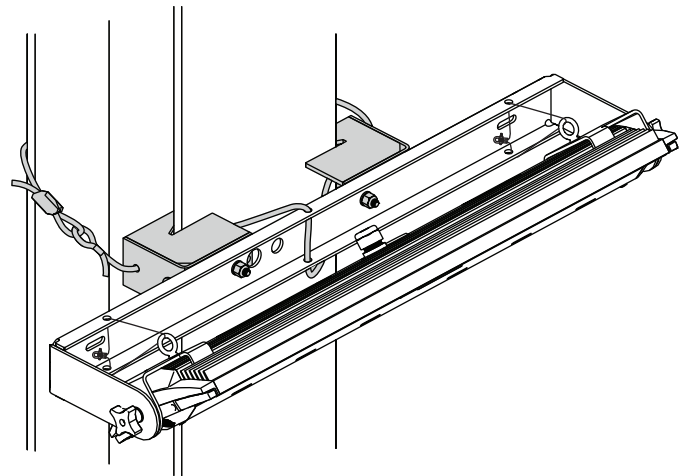
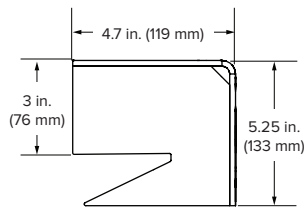
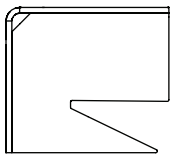
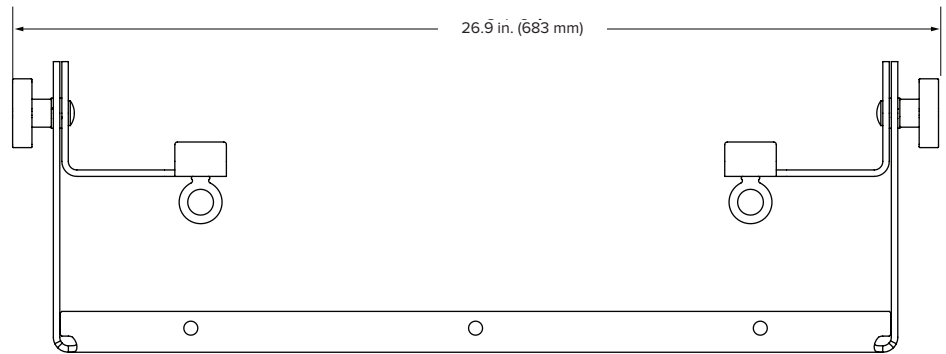
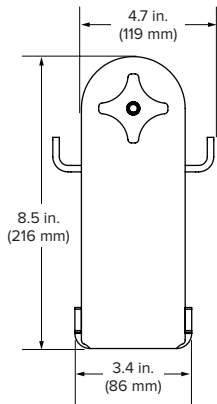
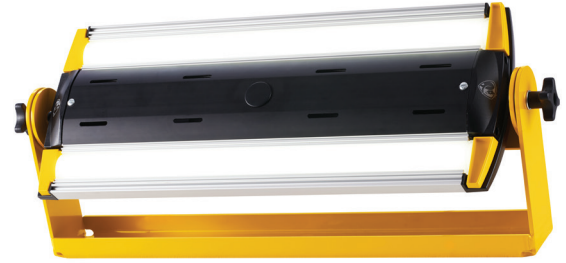

*See full warranty for coverage information.  
Specifications subject to change without notice.  
Lead times may vary depending on options selected.*



AMERICAS  
BIGASSOLUTIONS.COM  
877-244-3267

CANADA  
BIGASSOLUTIONS.COM/CA  
844-924-4277

AUSTRALIA  
BIGASSOLUTIONS.COM/AU  
1-300-244-277

SINGAPORE  
BIGASSOLUTIONS.COM/SG  
+65 6709 8500

MALAYSIA  
+603 5565 0888